Video-on-Demand

Technologies, Systems, and Applications

Jack Yiu-bun Lee
Department of Information Engineering
The Chinese University of Hong Kong

Preface

Jack Y.B. Lee

- **Target Audience**
 - ◆ Assumes engineering background;
 - ◆ No prior knowledge on multimedia and video technologies required.
- **Workshop Outline**
 - ◆ Part 1: Concepts
 - ◆ Part 2: Technologies
 - ◆ Part 3: Systems
 - ◆ Part 4: Applications

Table of Contents

Jack Y.B. Lee

1. CONCEPTS	5
1.1 What is Video-on-Demand (VoD)?	6
1.2 Types of Video Services	12
1.3 Major Challenges	17
2. TECHNOLOGIES	18
2.1 AV Signal Processing	19
2.2 Continuous Media	24
2.3 Coding and Compression	32
2.4 Storage	45
2.5 Network	52
3. SYSTEMS	91
3.1 Service Model	92
3.2 Video Retrieval	95
3.3 Admission Control	105
3.4 I/O Bandwidth	107
3.5 Storage Capacity	112
3.6 Video Delivery	116

Table of Contents

Jack Y.B. Lee

4. APPLICATIONS	127
4.1 Entertainment	128
4.2 Education and Training	129
4.3 Video Library	131
4.4 Networked Video Kioks	132
4.5 Online Commerce	134
5. SUMMARY	135
6. REFERENCES	136

Part 1 - Concepts

Jack Y.B. Lee

- Contents
 - ♦ 1.1 What is Video-on-Demand (VoD)?
 - ♦ 1.2 Types of Video Services
 - ♦ 1.3 Major Challenges

1.1 What is Video-on-Demand (VoD)?

Jack Y.B. Lee

- General System Overview

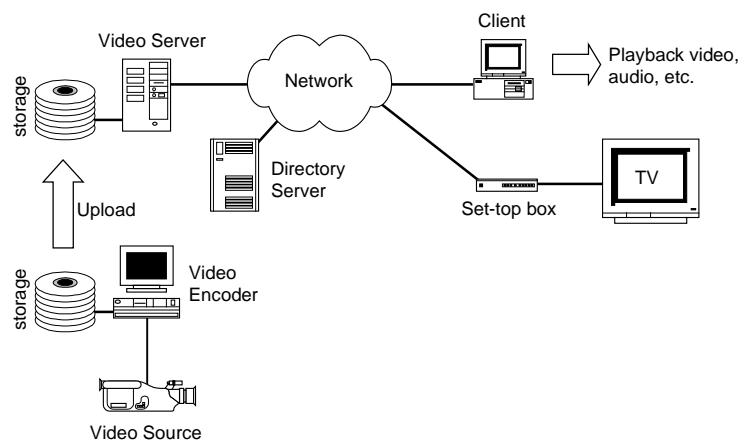

1.1 What is Video-on-Demand (VoD)?

Jack Y.B. Lee

- How is it different from traditional data servers?
 - ♦ The Download Model:

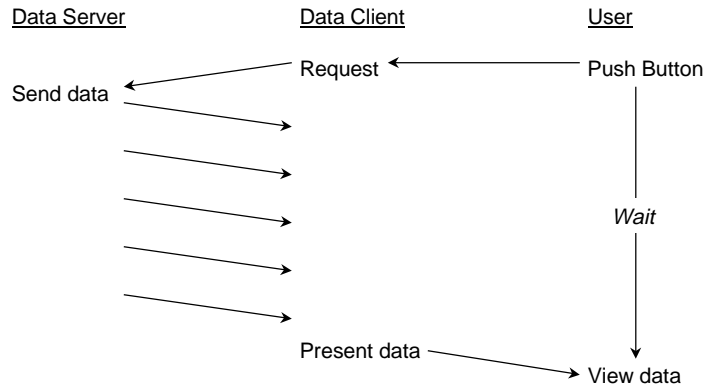

1.1 What is Video-on-Demand (VoD)?

Jack Y.B. Lee

- How is it different from traditional data servers?
 - ♦ The Download Model:

- Data Transfer Time T

$T = \text{Size of data} / \text{link speed}$

E.g. (a) Download a web page (10KB) through 28.8Kbps modem

$$T = 10 \times 8 / 28.8 = 2.78 \text{ seconds}$$

(b) Download a JPEG image (100KB) using 28.8Kbps modem

$$T = 100 \times 8 / 28.8 = 27.8 \text{ seconds}$$

(c) Download a one-hour MPEG1 video (540MB) using 28.8Kbps modem:

$$T = 540 \times 8 \times 1000 / 28.8 = 41.67 \text{ hours!}$$

- The Problem : Too much data, too little bandwidth!

1.1 What is Video-on-Demand (VoD)?

Jack Y.B. Lee

- How is it different from traditional data servers?

- ♦ The Download Model:

- Why not just use a high-speed network?

- Say, using 10Mbps Ethernet for an 1-hr MPEG1 video:

$$T = 540 \times 8 / 10 = 7.2 \text{ minutes}$$

*Much better, but will you wait 7 minutes to watch a video?
How about a full-length movie (2 hours)?*

- So how much bandwidth is needed?

If max waiting time is 10 seconds, then

$$C = 540 \times 8 / 10 = 432 \text{ Mbps}$$

- Hence simply raising bandwidth is not a good solution.

1.1 What is Video-on-Demand (VoD)?

Jack Y.B. Lee

- How is it different from traditional data servers?

- ♦ The Streaming Model:

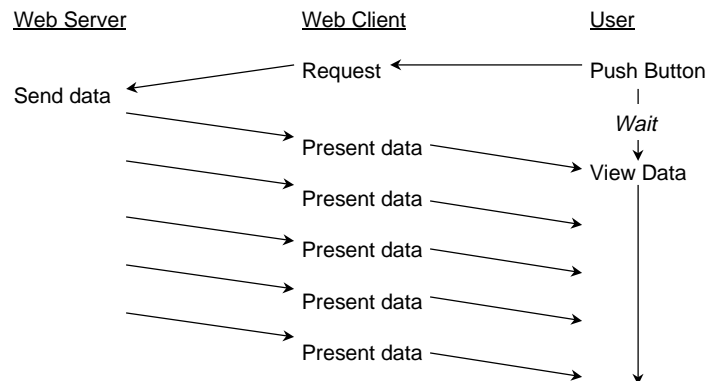

1.1 What is Video-on-Demand (VoD)?

Jack Y.B. Lee

- Requirement for Streaming
 - ♦ Data must be progressively decodable & presentable
 - Example: Video, minimum unit is one frame.
 - Counter Example: Program, partial program cannot run.
- Types of Streaming
 - ♦ Realtime
 - The data have a pre-determined sequence and time of presentation. For example, video and audio.
 - ♦ Non-Realtime
 - The data does not have presentation time requirement. For example, progressive JPEG.

1.2 Types of Video Services

Jack Y.B. Lee

- Broadcast / Multicast Video:

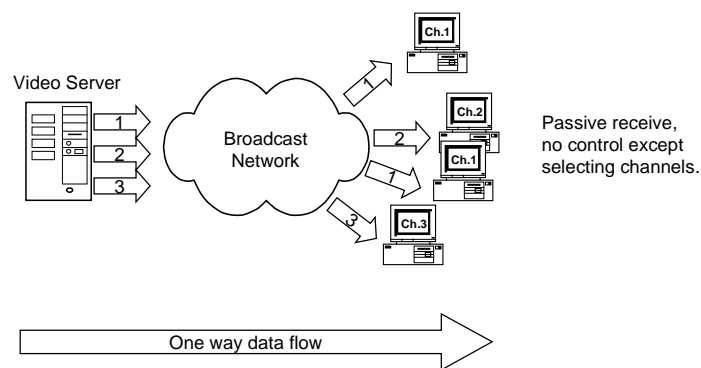

One channel is needed per movie / programme.

1.2 Types of Video Services

Jack Y.B. Lee

- Near-Video-on-Demand:

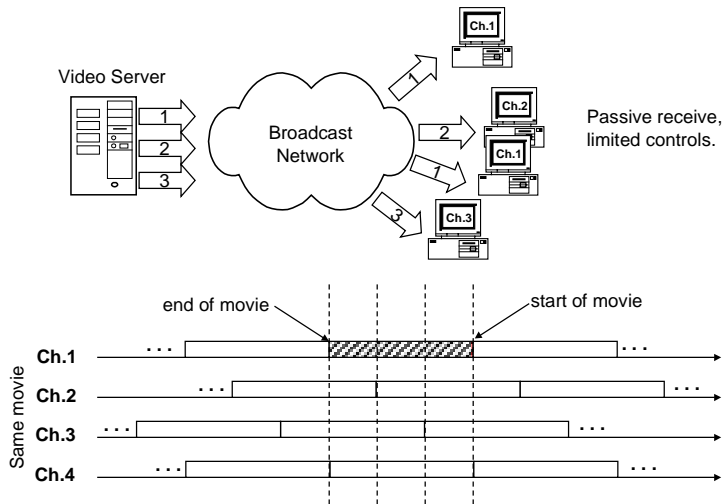

1.2 Types of Video Services

Jack Y.B. Lee

- Near-Video-on-Demand:

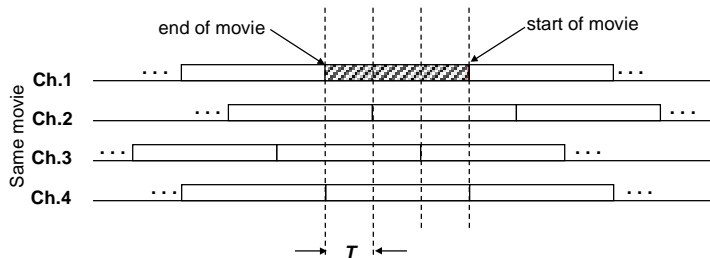

If movie length is L then number of channels needed per movie is: $N = L / T$

For example, if $L = 120$ minutes, $T = 10$ minutes,
then number of video channels needed $N = 120 / 10 = 12$ channels.

This also means that in the worst case, the user has to wait 10 minutes
before viewing a movie.

System response time inversely proportional to number of required channels.

1.2 Types of Video Services

Jack Y.B. Lee

- True Video-on-Demand

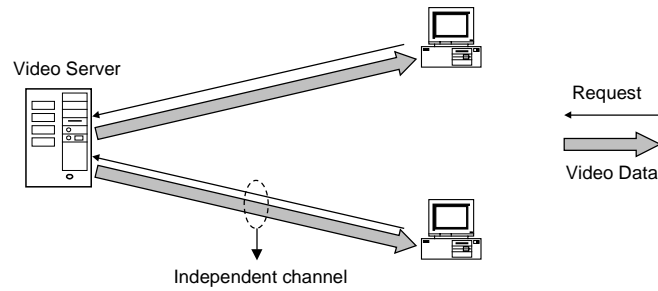

- Full interactive controls, like pause/resume, seeking, fast forward, etc.
- One video channel per user required.

1.2 Types of Video Services

Jack Y.B. Lee

- Comparisons:

	Broadcast Video	Near-Video-on-Demand (Pay-Per-View)	True Video-on-Demand
Select video?	Yes, but limited to a few channels	Yes, but limited to a few programmes	Yes
Select time to watch?	No	Yes (limited to fixed time slots)	Anytime
Interactive?	No	None or very little	VCR-like control
# of Viewers	Unlimited	Unlimited	Limited
Cost / Viewer	Low	Medium	High

1.3 Major Challenges

Jack Y.B. Lee

- Volume
 - ♦ High-quality digital video requires large amount of capacity in storage and delivery.
- Time Sensitivity
 - ♦ Video data must be delivered and presented according to a stringent timing schedule, otherwise the video playback will not be continuous.

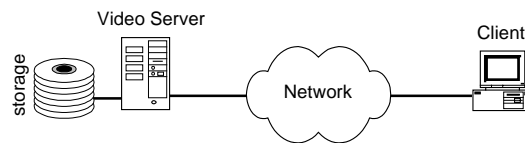

Part 2 - Technologies

Jack Y.B. Lee

- Contents
 - ♦ 2.1 AV Signal Processing
 - ♦ 2.2 Continuous Media
 - ♦ 2.3 Coding and Compression
 - ♦ 2.4 Storage
 - ♦ 2.5 Network

2.1 AV Signal Processing

Jack Y.B. Lee

- Analog and Digital Signals
 - ♦ From the physical world, a *sensor* transforms the time-dependent or space-dependent physical variables into electrical signals.
 - ♦ For example: recording audio

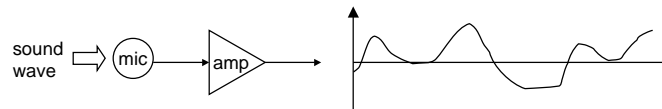

However, digital computer/systems cannot handle analog signals directly.

2.1 AV Signal Processing

Jack Y.B. Lee

- Analog and Digital Signals
 - ♦ We need Analog-to-Digital (A/D) Conversion:

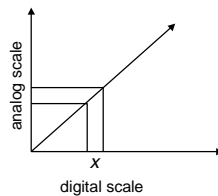

- Use a *number* to represent a *range of values* in the analog scale.
- For example, represent 5~10mV as 1, 10~15mV as 2, etc.

2.1 AV Signal Processing

Jack Y.B. Lee

- Analog-to-Digital (A/D) Conversion

- ♦ Sampling Accuracy

- The A/D conversion process is also referred to *quantization*.
- The problem is digital number covers a range of analog values, hence the mapping is not one-to-one.
- For example, a 7.5mV input converted to a digital number of 1 is only an *approximation*.
- Because another input of say 9.5mV will also be represented by a digital number of 1.

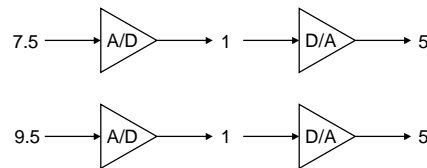

2.1 AV Signal Processing

Jack Y.B. Lee

- Analog-to-Digital (A/D) Conversion

- ♦ Sampling Accuracy

- The amount of digital numbers used is called quantization level, and is usually measured in bits.
- If n bits are used, then there are 2^n numbers or levels to represent *distinct* signal values.
- For example:
 - CD-audio uses 16 bits for audio, hence there are a total of 2^{16} or 65536 levels.
- A digital signal is usually represented as a binary *codeword*:
 - e.g. 01101001
 - = $(0 \times 2^7) + (1 \times 2^6) + (1 \times 2^5) + (0 \times 2^4) + (1 \times 2^3) + (0 \times 2^2) + (0 \times 2^1) + (1 \times 2^0)$
 - = $0 + 64 + 32 + 0 + 8 + 0 + 0 + 1$
 - = 105

2.1 AV Signal Processing

Jack Y.B. Lee

- Analog-to-Digital (A/D) Conversion
 - ♦ Sampling Rate
 - How often do we take samples of the analog signal and convert it to digital form?
 - For example:
 - If we take one sample every second, then the sampling rate is 1Hz.
 - CD audio uses a sampling rate of 44.1kHz.
 - How fast should I sample?
 - Nyquist in 1924 showed that if the sampling rate is *twice* the max. frequency of the signal, than no information will be lost.
 - Hence CD audio's 44.1kHz covers the entire range of human-audible frequencies (20~20kHz).

2.2 Continuous Media

Jack Y.B. Lee

- Digitizing Audio
 - ♦ Data Volume
 - Sampling frequency = B Hz
 - A/D precision = L bits
 - Data rate = $L \times B$ bits per second (or bps or b/s)
 - E.g. CD Audio

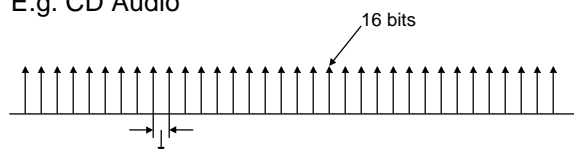

Fixed interval of 22.7 microseconds
($B = 44.1\text{kHz}$)

- Data rate $R = 44.1 \times 16 = 705.6$ kbps (mono)
- Data rate $R = 2 \times 705.6 = 1411.2$ kbps (stereo)

Periodic digital signals are also called continuous media or isochronous media.

2.2 Continuous Media

Jack Y.B. Lee

- Digitizing Video
 - ◆ Operation Model

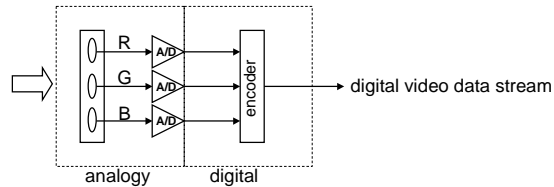

- ◆ Primary Colors
 - Red-Green-Blue (RGB)
 - Red = 700 nanometers light wave
 - Green = 546 nanometers light wave
 - Blue = 436 nanometers light wave

2.2 Continuous Media

Jack Y.B. Lee

- Digitizing Video
 - ◆ Analog Video Standards
 - NTSC (National Television Systems Committee)
 - In use in American, Canada, Japan, & Latin America, etc;
 - Signal Composition:
 - $Y = 0.30R + 0.59G + 0.14B$
 - $I = 0.74(R-Y) - 0.27(B-Y) = 0.60R + 0.28G + 0.32B$
 - $Q = 0.48(R-Y) + 0.41(B-Y) = 0.21R + 0.52G + 0.31B$
 - Interlaced scanning w/ 4:3 aspect ratio;
 - Resolution is 525 lines per frame at 29.97 frames per second (fps).

2.2 Continuous Media

Jack Y.B. Lee

- Digitizing Video
 - ♦ Analog Video Standards
 - PAL (Phase Alteration Line)
 - In use in Hong Kong, Europe, Australia, etc;
 - Signal Composition:
$$Y = 0.30R + 0.59G + 0.11B$$
$$U = 0.493(B-Y) = -0.15R - 0.29G + 0.44B$$
$$V = 0.877(R-Y) = 0.62R + 0.52G + 0.10B$$
 - Interlaced scanning w/ 4:3 aspect ratio;
 - Resolution is 625 lines per frame at 25 fps.
 - Others like SECAM, etc.

2.2 Continuous Media

Jack Y.B. Lee

- Digitizing Video
 - ♦ Digitization Model

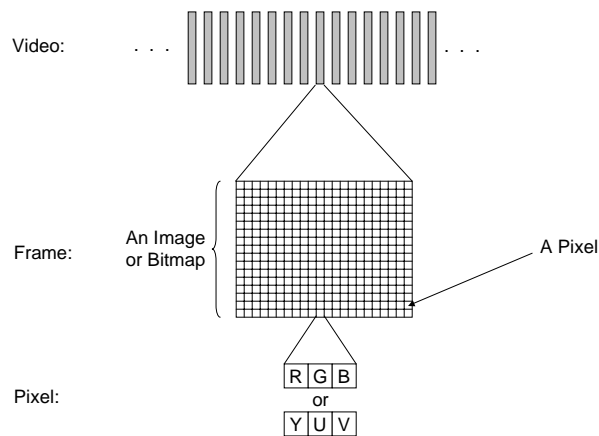

2.2 Continuous Media

Jack Y.B. Lee

- Digitizing Video
 - ◆ Digital Video Standards
 - Studio-Quality TV (ITU-R 601)
 - Sampling Rate: Y(13.5Mhz), U (6.75Mhz), V (6.75Mhz);
 - Digitizing NTSC Video Signal
 - Raw data rate = $(13.5+6.75+6.75) \times 8 = 216$ Mbps.
 - Raw Pixel Resolution = 864 x 525 pixels (removing retrace ,etc.).
 - Active Video Area = 720 x 486 pixels.
 - Sub-sampling (4:2:2) (reduce bit-rate by 33%)
Y (720x486), U (360x486), V (360x486)
 - 8-bits per sample per signal channel.
 - Net data rate after sub-sampling = **168 Mbps**.
 - HDTV (US)
 - 720,000 pixels per frame
 - 24 bits per pixel
 - 60 fps
 - Data rate = **1.0368 Gbps**.

2.2 Continuous Media

Jack Y.B. Lee

- Digitizing Video
 - ◆ Digital Video Standards
 - Videoconferencing Quality - CIF
 - Common Interchange Format (CIF), (ITU-TS H.261)
 - Frame size (4:1:1 sub-sampling):
 - 352 x 288 for luminance (Y)
 - 176 x 144 for chrominances (U, V)
 - Data rate = **36 Mbps**.
 - Videoconferencing Quality - QCIF
 - Quarter-Common Interchange Format (QCIF)
 - Frame size:
 - 176 x 144 for luminance (Y)
 - 176 x 144 for chrominances (U, V)
 - Data rate = **18 Mbps**.

2.2 Continuous Media

Jack Y.B. Lee

- Digitizing Video
 - ◆ Digital Video Standards
 - Videoconferencing Quality - Super-CIF
 - Super-Common Interchange Format (Super-CIF)
 - Frame size (4:1:1 sub-sampling):
 - 704 x 576 for luminance (Y)
 - 352 x 288 for chrominances (U, V)
 - Data rate = **146 Mbps**.
 - VCR Quality - SIF
 - Standard Interchange Format (Defined in MPEG-1)
 - Frame size (4:1:1 sub-sampling):
 - 352 x 240 (NTSC) or 352 x 288 (PAL/SECAM) for luminance (Y)
 - 176 x 120 or 144 for chrominances (U, V)

2.3 Coding and Compression

Jack Y.B. Lee

- Motivation
 - ◆ Digital audio and video generates vast amount of data that are difficult to process and deliver quickly.
- What is compression?
 - ◆ Reduce the number of bits used to encode the same information by exploiting:
 - Spatial redundancy
 - Correlation between neighboring pixels
 - Spectral redundancy
 - Correlation between color components
 - Psycho-visual redundancy
 - Perceptual properties of the human visual system

2.3 Coding and Compression

Jack Y.B. Lee

- Types of compression
 - ♦ Lossless compression
 - No information is loss in the encode/decode process.
 - ♦ Lossy compression
 - Some information is loss in the encode/decode process.
- A Generic Model for Compression:

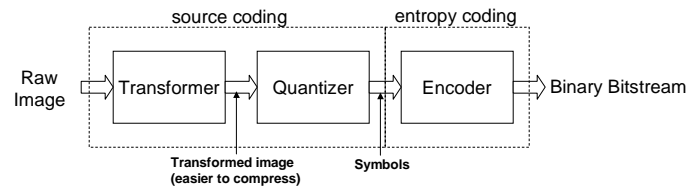

2.3 Coding and Compression

Jack Y.B. Lee

- A Generic Model for Compression
 - ♦ Transformer
 - A one-to-one mapping to transform the signal from the spatial domain to other domains, which are easier to compress.
 - Common transformers
 - Discrete Cosine Transform (DCT)
 - Wavelet Transform
 - ♦ Quantizer
 - A many-to-one mapping to reduce the data rate.
 - Loss in information is introduced in this stage.
 - ♦ Encoder
 - Maps symbols generated by Quantizer to bit-strings.
 - Exploits statistical knowledge to reduce bit rate.

2.3 Coding and Compression

Jack Y.B. Lee

- MPEG Compression Standards
 - ♦ MPEG standards for Motion Picture Expert Group
 - It is a standard for video compression.
 - ♦ Composition
 - MPEG-1
 - VCR-quality video up to 8 Mbps;
 - Used in Video-CD, CD-I and Video-on-Demand systems.
 - MPEG-2
 - Broadcast quality video from 3 to >10 Mbps;
 - Used in DVD, HDTV, and Video-on-Demand systems.
 - MPEG-3
 - Originally slated for HDTV but later dropped due to the incorporation of HDTV into MPEG-2.
 - MPEG-4
 - Low-bit rate video for video telephony systems.

2.3 Coding and Compression

Jack Y.B. Lee

- MPEG System Structure
 - ♦ Encoding Process:

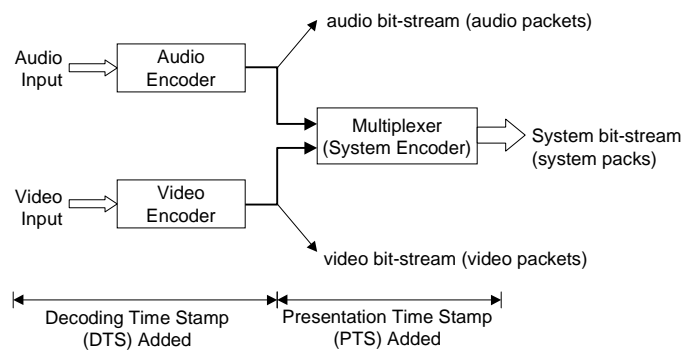

2.3 Coding and Compression

Jack Y.B. Lee

- MPEG System Structure
 - ◆ Bit-stream Structure
 - Audio and video are compressed and encoded individually into audio packets and video packets.
 - Decoding Time Stamps (DTS) are added to the packets to guide the decoder controller in the decoding process.
 - The audio and video packets are then multiplexed into a system stream by a system encoder (or multiplexer).
 - Presentation Time Stamps (PTS) are then added to *synchronize* the audio and video streams.

2.3 Coding and Compression

Jack Y.B. Lee

- MPEG System Structure
 - ◆ Audio Compression
 - How does it work?
 - MPEG Audio strips information in the audio signal that is less sensitive to the human perception system (ear).
 - This is called "perceptual coding".
 - MPEG Audio Layers
 - The Layer I psychoacoustic model only uses frequency masking.
 - This means that it strips frequencies that are hidden behind others. You shouldn't encode at higher compression than 384 Kbps.
 - Layer II does more filtering.
 - In layman's terms, it decides better what information can be stripped. Encoding at 160 Kbps sounds good, at 192 Kbps it becomes difficult to hear the difference, and at 256 Kbps and above produce very good quality audio.

2.3 Coding and Compression

Jack Y.B. Lee

- MPEG System Structure

- Audio Compression

- MPEG Audio Layers

- Layer III is the most complex MPEG Audio model.

- It does even more filtering than Layer II and uses a Huffman coder. While encoding at 112 Kbps sounds good, 128 Kbps is even closer to the original; at 160 Kbps and 192 Kbps you won't hear a difference to the original.

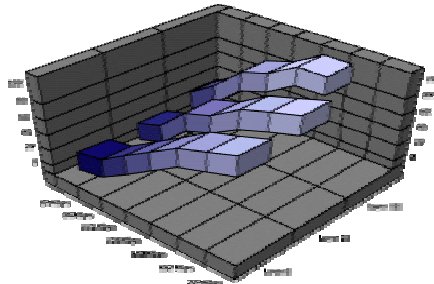

2.3 Coding and Compression

Jack Y.B. Lee

- MPEG System Structure

- Video Compression

- Two Basic Compression Techniques:

- Block-based motion compensation for the reduction of the **temporal redundancy**, and
- Transform domain (DCT) coding for the reduction of **spatial redundancy**.

- Temporal Redundancy Reduction

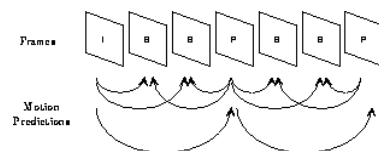

Three types of frames: intra pictures (I frames), predicted pictures (P frames), and bidirectionally interpolated pictures (B frames).

2.3 Coding and Compression

Jack Y.B. Lee

- MPEG System Structure

- ♦ Video Compression

- Spatial Redundancy Reduction

- For the reduction of spatial redundancy in each I picture or the prediction error in P and B pictures, the MPEG standard uses

- Discrete cosine transform (DCT)
 - Quantization
 - Run-length encoding
- } source coding
} entropy coding

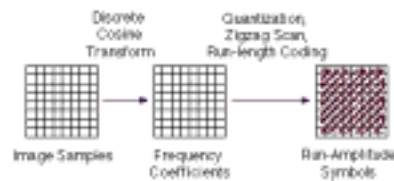

2.3 Coding and Compression

Jack Y.B. Lee

- Compression and VoD

- ♦ Two Types Compression

- Constant Bit-Rate (CBR)

- The bit-rate of the compressed video stream over a short time interval is constant.
- The video quality is not constant. Loosely speaking, more motions degrade video quality.
- CBR videos are good for system design but bad for the user.

- Variable Bit-Rate (VBR)

- The video quality is constant for the entire video stream.
- The bit-rate is adjusted to maintain a constant video quality.
- VBR videos are good for the user but bad for system design.

2.4 Storage

Jack Y.B. Lee

- System Model

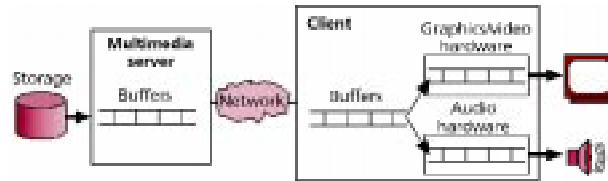

- Challenges

- ◆ Real-time storage and retrieval:
 - Continuous media data must be presented using the same timing sequence with which they were captured.
 - Any deviation from this timing sequence can lead to artifacts such as jerkiness in video motion, pops in audio, or possibly complete unintelligibility.

2.4 Storage

Jack Y.B. Lee

- Challenges

- ◆ Real-time storage and retrieval:
 - Media components may also need *synchronization*. For example, a video stream must synchronize an audio stream in a movie.
- ◆ High data transfer rate and large storage space:
 - Digital video and audio playback demands a high data transfer rate, so that storage space is rapidly filled. (E.g. MPEG1 ~ 1.5Mbps, MPEG2 ~ 4Mbps)
 - The server must efficiently store, retrieve, and manipulate data in large quantities at high speeds.

2.4 Storage

Jack Y.B. Lee

- Disk Model

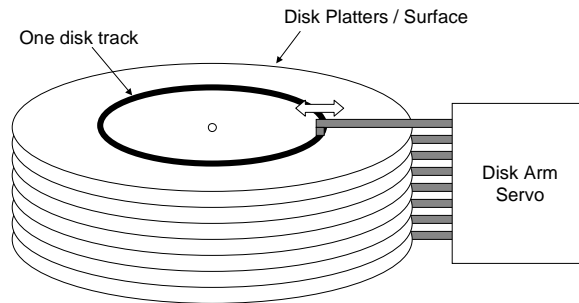

- ◆ The disk platters spin at speed from 3600rpm to 10000rpm;
- ◆ Disk heads in all platters move together.
- ◆ A disk track is further divided into disk sectors.

2.4 Storage

Jack Y.B. Lee

- Disk Model

- ◆ Fixed Delays
 - Processing delay at disk controller;
 - Delay at data bus (e.g. SCSI) between disk and controller;
 - Head-switching time;
- ◆ Variable Delays
 - Rotational Latency
 - Depends on position and spindle speed
 - Seek time
 - Depends on number of tracks to seek
 - Transfer Time
 - Depends on how much data to transfer to host

2.4 Storage

Jack Y.B. Lee

- Disk Model

- ♦ Disk-Seek Time Function:

$$T_{seek}(n) = \alpha + \beta\sqrt{n}$$

Number of tracks to seek
Seek-time constant (sec)
Fixed overhead (sec)

- ♦ Total Disk-Read Time Function:

$$T_{read}(n) = \alpha + \beta\sqrt{n} + T_{latency} + \frac{Q}{R_{disk}}$$

Size of data to read (Bytes)
Disk transfer rate (Bytes/sec)
Rotational latency (sec)

2.4 Storage

Jack Y.B. Lee

- Typical Disk Parameters

- ♦ Seagate 4GB ST12400N (SCSI-2)

Disk Parameter	Value
Spindle speed	5411 rpm
Max latency (r)	11ms
Number of tracks	2621
Raw transfer rate	3.35MB/s
Single-track seek	1ms
Max full-stroke seek	19ms

2.4 Storage

Jack Y.B. Lee

- Typical Disk Parameters
 - ♦ SCSI Variants

Types	Variants	Max. Speed	Number of Devices	Max. Cable Length
SCSI-1	-	5 MB/s	8	6m
SCSI-2	Fast SCSI	10 MB/s	8	1.5m~3m
	Fast Wide SCSI	20 MB/s	16	1.5m~3m
SCSI-3	Ultra SCSI	20 MB/s	8	1.5m
	Wide Ultra SCSI	40 MB/s	16	1.5m
	Ultra2 SCSI	40 MB/s	8	12m
	Wide Ultra2 SCSI	80 MB/s	16	12m
	Ultra3 SCSI	80 MB/s	8	12m
	Wide Ultra3 SCSI	160 MB/s	16	12m
Fibre Channel	FC-AL	100~200MB/s	126	30m~10km

- Note that the "Max. Speed" is the top speed of the interface.
- The actual achievable speed depends on the performance of the connected disks.

2.5 Network

Jack Y.B. Lee

- Basic Concepts
 - ♦ Classification by Transmission Technology:
 - Broadcast networks
 - Point-to-point networks
 - ♦ Broadcast Networks
 - A *single* communication channel is *shared* by all hosts.
 - A host sends packets on the channel, which are then received by all hosts. An *address field* within a packet is used to identify the intended receiver.
 - Special addresses: Broadcast address & multicast address

2.5 Network

Jack Y.B. Lee

- Basic Concepts
 - ◆ Point-to-Point Networks
 - Each communication channel links up two hosts.
 - To go from one host to another, intermediate hosts may need to be traversed (routing).

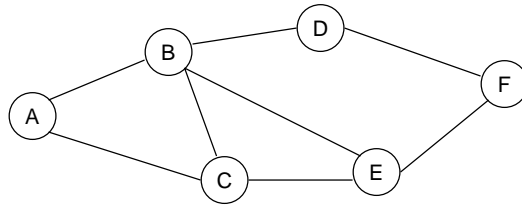

2.5 Network

Jack Y.B. Lee

- Basic Concepts
 - ◆ Classification by Scale or Distance

Interprocessor distance	Processors located in same	Example
0.1 m	Circuit board	Data flow machine
1 m	System	Multicomputer
10 m	Room	Local area network
100 m	Building	
1 km	Campus	
10 km	City	Metropolitan area network
100 km	Country	Wide area network
1,000 km	Continent	
10,000 km	Planet	The internet

2.5 Network

Jack Y.B. Lee

- Basic Concepts
 - ♦ Local Area Networks (LANs)
 - Restricted in size (up to one km)
 - Mostly are broadcast networks
 - Speeds range from 10Mbps to 100Mbps
 - Low error rate
 - Low latency

```
c:\>ping adnetpc0.ie.cuhk.edu.hk

Pinging adnetpc0.ie.cuhk.edu.hk [137.189.97.120] with 32 bytes of data:

Reply from 137.189.97.120: bytes=32 time<10ms TTL=128
Reply from 137.189.97.120: bytes=32 time<10ms TTL=128
Reply from 137.189.97.120: bytes=32 time<10ms TTL=128
Reply from 137.189.97.120: bytes=32 time<10ms TTL=128
```

2.5 Network

Jack Y.B. Lee

- Basic Concepts
 - ♦ Wide Area Networks (WANs)
 - Spans large geographical area (country or continent).
 - Connects subnets in a local area (LAN).

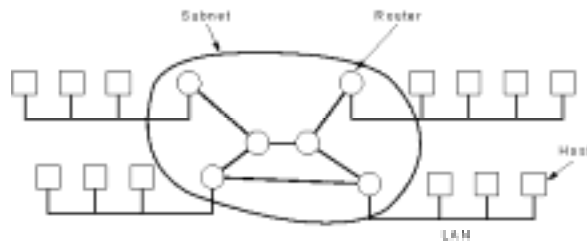

2.5 Network - Hardware

Jack Y.B. Lee

- The IEEE 802 Series Standards
 - ♦ IEEE 802.1 - Introduction to the 802 series standards;
 - ♦ IEEE 802.2 - Logical Link Control (LLC) Protocol
 - ♦ IEEE 802.3 - CSMA/CD (Ethernet)
 - ♦ IEEE 802.4 - Token Bus
 - ♦ IEEE 802.5 - Token Ring
 - ♦ IEEE 802.6 - Distributed Queue Dual Bus (MAN)
- Others
 - ♦ FDDI (Fiber Distributed Data Interface)
 - ♦ ATM (Asynchronous Transfer Mode)

2.5 Network - Hardware

Jack Y.B. Lee

- Ethernet (IEEE 802.3)
 - ♦ Broadcast Physical Network (CSMA/CD)
 - ♦ Maximum end-to-end distance is 2500 meters
 - ♦ Speed is 10Mbps shared by all stations on the network
 - ♦ Cabling

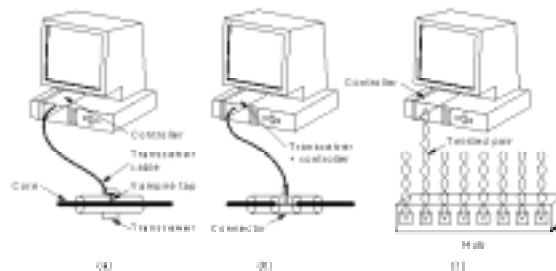

2.5 Network - Hardware

Jack Y.B. Lee

- Ethernet (IEEE 802.3)
 - ♦ Switched Ethernet
 - A 802.3 LAN will eventually saturate when more and more stations are added.
 - To increase capacity, one may upgrade to higher data rate such as 100Mbps or even 1Gbps. This approach is expensive because all network cards and associated equipment have to be upgraded (replaced).
 - The Solution is Switched LANs!

2.5 Network - Hardware

Jack Y.B. Lee

- Ethernet (IEEE 802.3)
 - ♦ Switched Ethernet

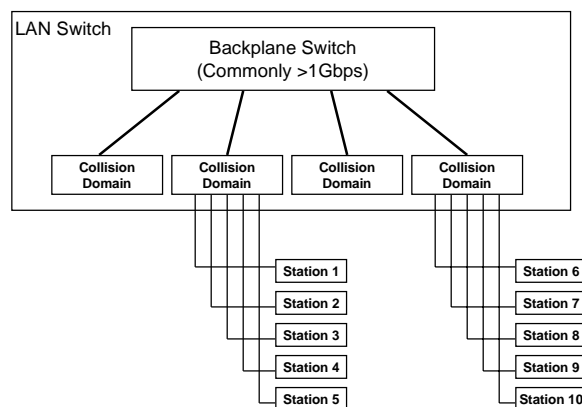

2.5 Network - Hardware

Jack Y.B. Lee

- Ethernet (IEEE 802.3)
 - ◆ Good
 - Most popular
 - Shortest delay at low load
 - Simple protocol, passive cable
 - ◆ Bad
 - Substantial analog operation (carrier sense, collision detection)
 - Frame size must be at least 64 bytes
 - Non-deterministic delay (due to collision)
 - No priorities
 - Cable length limited to 2.5km at 10Mbps
 - Performance deteriorates at high load

2.5 Network - Hardware

Jack Y.B. Lee

- Token Ring (IEEE 802.5)
 - ◆ History
 - Proposed by IBM
 - Targeted at business networks
 - ◆ Physical Layer
 - Cabling: Shielded twisted pairs
 - Data Rate: 1, 4, or 16Mbps
 - ◆ MAC Sublayer
 - Token passing, collision free.

2.5 Network - Hardware

Jack Y.B. Lee

- Token Ring (IEEE 802.5)
 - ♦ Data bits circulate around the token ring in one direction.

Let data rate be R Mbps, then 1 bit is emitted every $1/R$ μ sec.
With signal propagation speed of $200\text{m}/\mu\text{sec}$,
each bit occupies $200/R$ meters on the ring.

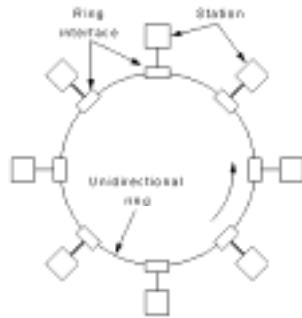

2.5 Network - Hardware

Jack Y.B. Lee

- Token Ring (IEEE 802.5)
 - ♦ Good
 - Fewer analog components
 - Supports any cabling
 - Resilience to cable failures (through the use of wire center)
 - Supports priorities
 - Excellent throughput and efficiency at high load
 - ♦ Bad
 - Substantial delay at low load (due to token passing)
 - Malfunction monitor station can bring down the ring
 - Less popular

2.5 Network - Software

Jack Y.B. Lee

- Protocol Hierarchies
 - ♦ Network systems are broken down into multiple *layers*.
 - ♦ Each layer offers a well-defined interface to provide *services* to the upper layers.
 - ♦ A *protocol* is defined at each layer for exchanging information between two *peers*.

2.5 Network - Software

Jack Y.B. Lee

- Protocol Hierarchies
 - ♦ An example protocol hierarchy:

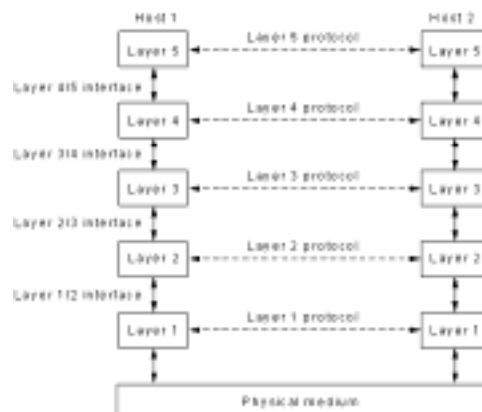

2.5 Network - Software

Jack Y.B. Lee

- Protocol Processing
 - ♦ Headers are added and removed
 - ♦ A message may be broken down into multiple segments

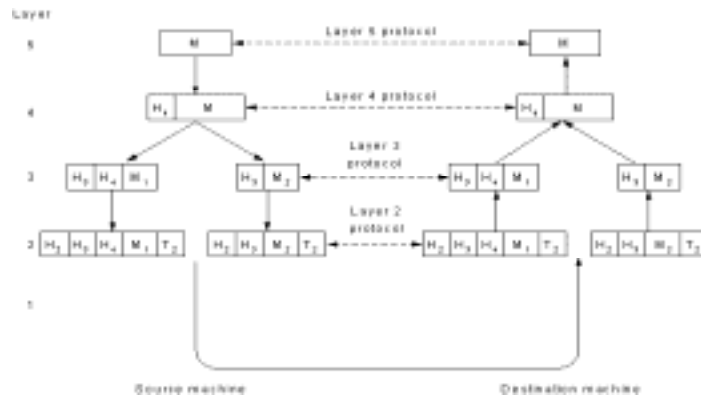

Video-on-Demand - Technologies, Systems, and Applications

67

2.5 Network - Software

Jack Y.B. Lee

- Protocol Software
 - ♦ A protocol layer provides services to upper layers.
 - ♦ Types of Services
 - Connection-Oriented versus Connectionless Services
 - Connection setup required?
 - Analogy: Telephone versus Postal Mail
 - Reliable versus Unreliable Services
 - Automatic recover from errors?
 - Stream versus Message Services
 - Preserve message boundary?

Video-on-Demand - Technologies, Systems, and Applications

68

2.5 Network - Reference Models

Jack Y.B. Lee

- What?
 - ♦ A reference model is an architecture for layered network communications.
- The OSI Reference Model
 - ♦ Developed by the International Standards Organization (ISO).
 - ♦ The model is called Open Systems Interconnection (OSI).
 - ♦ Consists of *seven* layers.

2.5 Network - Reference Models

Jack Y.B. Lee

- The OSI Reference Model



2.5 Network - Reference Models

Jack Y.B. Lee

- The OSI Reference Model
 - ♦ Physical Layer
 - Concerns transmitting *raw bits* (0 and 1) over a *physical communication channel* (copper wire, fibre optic cable, wireless media).
 - ♦ Data Link Layer
 - Provides a service which is free of *undetected* transmission errors.
 - Optionally provides error control and flow control.
 - Coordinating transmissions and receptions on the same link.
 - Resolve contentions in broadcast networks.

2.5 Network - Reference Models

Jack Y.B. Lee

- The OSI Reference Model
 - ♦ The Network Layer
 - Concerned with controlling the operation of the *subnet*.
 - Handles routing of a packet from source to destination.
 - Handles congestions.
 - Keeps accounting information if needed.
 - Converts between incompatible addressing schemes and packet formats.
 - ♦ The Transport Layer
 - Provides an error-free connection on an *end-to-end* basis.
(Unreliable messages service is also possible.)
 - Handles upward and downward multiplexing.
 - Handles name resolution across the entire network.
 - Handles flow control between sender and receiver.

2.5 Network - Reference Models

Jack Y.B. Lee

- The OSI Reference Model
 - ◆ The Session Layer
 - Provides session management
 - dialogue control
 - token management
 - synchronization or crash recovery
 - ◆ The Presentation Layer
 - Concerns the syntax and semantics of the information transmitted
 - Performs information encoding and decoding to facilitate the exchange of information
 - Text: ASCII versus Unicode
 - Numbers: byte ordering and byte size differences

2.5 Network - Reference Models

Jack Y.B. Lee

- The OSI Reference Model
 - ◆ The Application Layer
 - Defines the protocols and services for a specific application.
 - Examples:
 - File Transfer (FTP)
 - Email (SMTP, POP3)
 - WWW (HTTP)
 - Network News (NNTP)
 - Video Streaming Protocols

2.5 Network - Reference Models

Jack Y.B. Lee

- The TCP/IP Reference Model

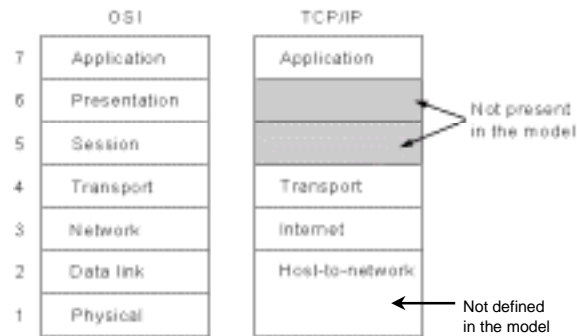

These are reference models.

2.5 Network - Reference Models

Jack Y.B. Lee

- The TCP/IP Reference Model

- ◆ Protocols and Networks



This is a protocol stack conforming to the TCP/IP reference model.

2.5 Network - Reference Models

Jack Y.B. Lee

- The TCP/IP Reference Model
 - ◆ The Internet Layer
 - Protocol used: Internet Protocol (IP)
 - Assumes a packet-switching network
 - Connectionless
 - Handles routing of IP packets
 - Handles congestion
 - Similar to OSI's network layer

2.5 Network - Reference Models

Jack Y.B. Lee

- The TCP/IP Reference Model
 - ◆ The Transport Layer
 - Protocol one: Transmission Control Protocol (TCP)
 - Provides a *reliable, connection-oriented, stream* service.
 - Handles data packetization and reassembly.
 - Handles flow control, sequencing, and error recovery.
 - Handles designation among processes in the same host by means of service port numbers.
 - Protocol two: User Datagram Protocol (UDP)
 - Provides an *unreliable, connectionless, datagram* service.
 - Handles designation among processes in the same host by means of service port numbers.
 - No flow control, sequencing, and error recovery.

2.5 Network - Reference Models

Jack Y.B. Lee

- The TCP/IP Reference Model

- ♦ The Application Layer

Services

Virtual Terminal

File Transfer

Electronic Mail

Name Resolution

Network News

World Wide Web

Streaming Video

Network File System

Network Management

-

-

-

-

-

-

-

-

-

Protocols

TELNET

FTP

SMTP/POP3

DNS

NNTP

HTTP

RTSP

NFS

SNMP

2.5 Network - High-Speed Technologies

Jack Y.B. Lee

- FDDI (Fiber Distributed Data Interface)

- ♦ A token ring running at 100Mbps on optical fibers.
 - ♦ Max ring size is 200km, up to 1000 stations.
 - ♦ Commonly used as backbone for connecting multiple LANs.

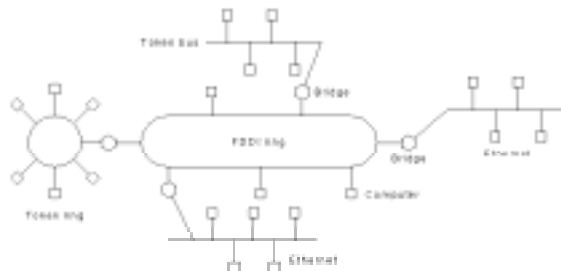

2.5 Network - High-Speed Technologies

Jack Y.B. Lee

- Fast Ethernet
 - ♦ A faster version of 802.3 Ethernet, running at 100Mbps.
 - ♦ The max cable length is reduced by a factor of 10.
 - ♦ Cabling

Name	Cable	Max. segment	Advantages
100Base-T4	Twisted pair	100 m	Uses category 3 UTP
100Base-TX	Twisted pair	100 m	Full duplex at 100 Mbps
100Base-F	Fiber optics	2000 m	Full duplex at 100 Mbps; long runs

- ♦ Full Duplex
 - A station can send and receive *simultaneously*.

2.5 Network - High-Speed Technologies

Jack Y.B. Lee

- Gigabit Ethernet
 - ♦ An even faster version of 802.3 Ethernet, running at 1000Mbps (1Gbps).
 - ♦ Cabling: Fiber optic or CAT-5 UTP
 - ♦ The good thing about 802.3 series of Ethernet is that they are compatible with each other.

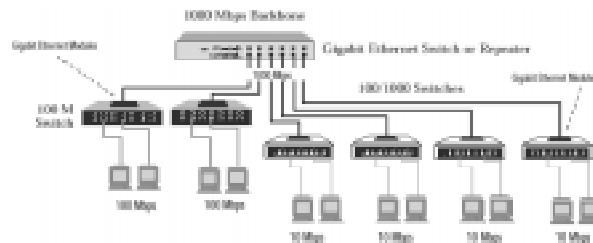

2.5 Network - High-Speed Technologies

Jack Y.B. Lee

- Asynchronous Transfer Mode (ATM)
 - ♦ Designed to integrate all existing types of communication networks, including
 - Plain Old Telephone Service (POTS)
 - Public Switched Data Networks (PSDN)
 - Telephone company call management network (SSN7)
 - Cable Television Network
 - Video-on-Demand Service Network

2.5 Network - High-Speed Technologies

Jack Y.B. Lee

- Asynchronous Transfer Mode (ATM)
 - ♦ Basic ATM Technology
 - Packet switching with small packets (53 bytes) called cells.

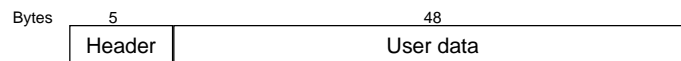

An ATM cell

- Connection-oriented, guarantees in-sequence but not delivery.
- Speeds range from 25Mbps to 622Mbps and further.
- Supports Quality-of-Service (QoS) on a connection.
 - Delay, delay jitter, average and peak bandwidth, loss rate, etc.

2.5 Network - High-Speed Technologies

Jack Y.B. Lee

- Asynchronous Transfer Mode (ATM)
 - ♦ The ATM Protocol Stack

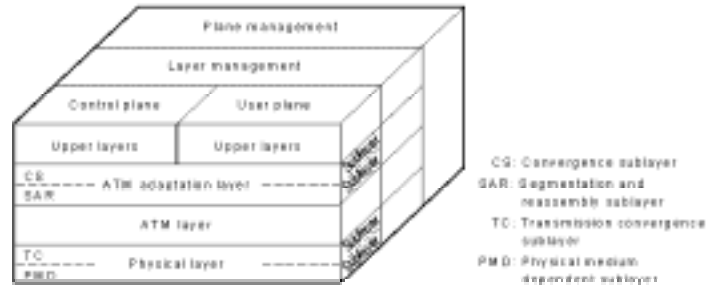

2.5 Network - High-Speed Technologies

Jack Y.B. Lee

- Asynchronous Transfer Mode (ATM)
 - ♦ ATM Layer (Network Layer)
 - Connection-oriented.
 - Use fixed-size (53 bytes) packets called ATM cells.
 - ♦ ATM Adaptation Layer (Transport Layer, *sort of*)
 - Adds functionalities to provide specific services to different classes of applications.



2.5 Network - High-Speed Technologies

Jack Y.B. Lee

- Asynchronous Transfer Mode (ATM)
 - ♦ Types of ATM Adaptation Layer Protocols
 - AAL 1, AAL2, AAL 3/4, AAL 5
 - ♦ AAL 1
 - Services
 - For real-time, constant bit rate, connection-oriented, stream traffic.
 - Applications
 - Such as uncompressed audio and video or
 - A/V compressed using Constant-Bit-Rate (CBR) compression.
 - Error Control
 - Notify application of cell loss, no automatic recovery.

2.5 Network - High-Speed Technologies

Jack Y.B. Lee

- Asynchronous Transfer Mode (ATM)
 - ♦ AAL 2
 - Services
 - For variable-bit-rate, connection-oriented, datagram traffic.
 - Applications
 - A/V compressed using Variable-Bit-Rate (CBR) compression.
 - Catch!
 - AAL 2 is *not usable* because the standard does not specify length of header fields.
 - This is intentional(!) because AAL 2 has many problems which cannot be solved in time for standardization.

2.5 Network - High-Speed Technologies

Jack Y.B. Lee

- Asynchronous Transfer Mode (ATM)
 - ◆ AAL 3/4
 - Originally two protocols, AAL 3 & AAL 4, for connection-oriented & connection-less services respectively.
 - Later merged into a single protocol due to too much overlapping functions.
 - Services (2 modes)
 - Supports stream & message, reliable & unreliable delivery.
 - Supports multiplexing:

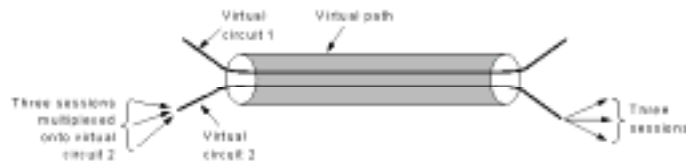

2.5 Network - High-Speed Technologies

Jack Y.B. Lee

- Asynchronous Transfer Mode (ATM)
 - ◆ AAL 5
 - History
 - AAL 1 to 3/4 are primary designed by the telecom industry.
 - AAL 5 is designed by the computer industry.
 - Similar to AAL 3/4 but more efficient.
 - Services
 - Reliable, non-real-time, with flow control.
 - Unreliable, non-real-time, unicast & multicast.
 - Stream or message modes.
 - Applications
 - Transporting IP packets over AAL 5.

Part 3 - Systems

Jack Y.B. Lee

- Contents
 - ◆ 3.1 Service Model
 - ◆ 3.2 Video Retrieval
 - ◆ 3.3 Admission Control
 - ◆ 3.4 I/O Bandwidth
 - ◆ 3.5 Storage Capacity
 - ◆ 3.6 Video Delivery

3.1 Service Model

Jack Y.B. Lee

- What?
 - ◆ How video data are *scheduled* for delivery from the video server to a video client.
- Types of Service Model
 - ◆ Client-Pull v.s. Server Push

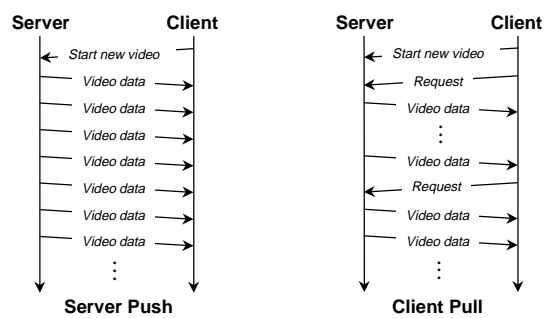

3.1 Service Model

Jack Y.B. Lee

- Client-Pull
 - ◆ Advantages
 - Simple server design;
 - Supports any video bit-rate, CBR and VBR;
 - Better tolerance to delay and delay jitter;
 - ◆ Disadvantages
 - A backward network channel (upstream) from client to server is necessary;
 - More complicated client machine;
 - May requires more buffering at the client.
 - ◆ Common Applications
 - Local Area Networks (LAN) based VoD systems.

3.1 Service Model

Jack Y.B. Lee

- Server-Push
 - ◆ Advantages
 - A backward network channel (upstream) from client to server is not needed (desirable in certain applications like satellite broadcast);
 - May requires less buffering at the client;
 - More predictable performance;
 - Easier to optimize server performance.
 - ◆ Disadvantages
 - Requires real-time hardware and software at the server;
 - Difficult to support mixed bit-rate and VBR videos;
 - Less tolerance to delay and delay jitter;
 - ◆ Common Applications
 - All kinds of VoD systems, particularly WAN-based and satellite video broadcast.

3.2 Video Retrieval

Jack Y.B. Lee

- The Bandwidth Landscape:

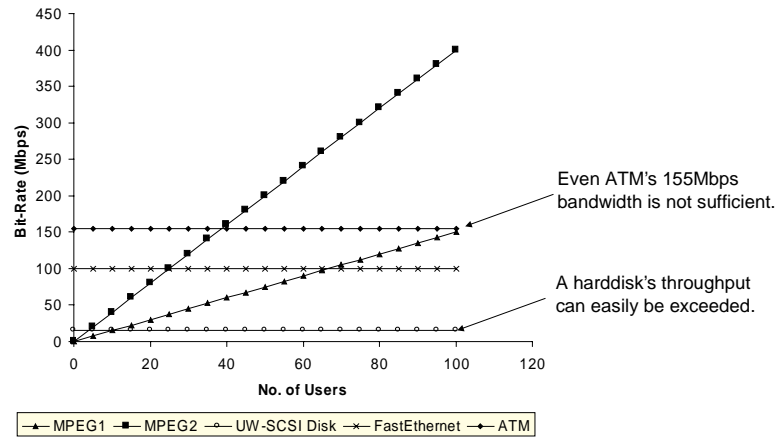

3.2 Video Retrieval

Jack Y.B. Lee

- Single-Stream Retrieval

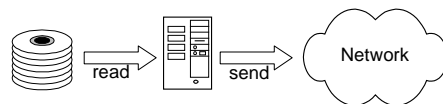

- Ideal Disk (Constant Service Time)

Constant delay: $d_i = d_j \forall i, j$

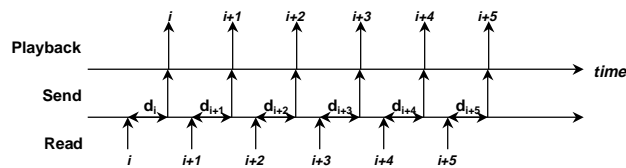

Assumes zero transmission time in network.

3.2 Video Retrieval

Jack Y.B. Lee

- Single-Stream Retrieval
 - ♦ In Practice (Variable Service Time)
 - Variable delay can cause playback glitches:

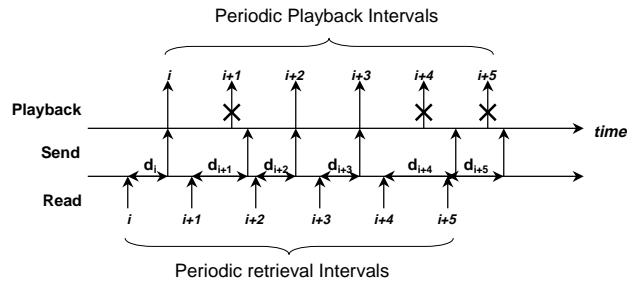

3.2 Video Retrieval

Jack Y.B. Lee

- Single-Stream Retrieval
 - ♦ In Practice (Variable Service Time)
 - Buffering At Server:

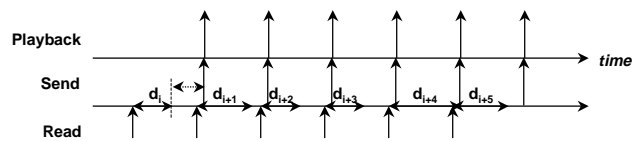

- Buffering At Receiver:

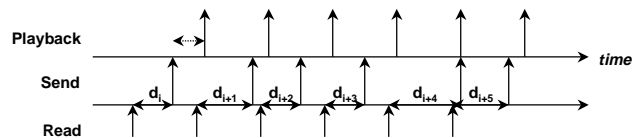

3.2 Video Retrieval

Jack Y.B. Lee

- Disk Scheduling Algorithms for VoD Servers

- ♦ Characteristic of Continuous Media

- Periodic retrieval of fixed-size data blocks;
- The entire retrieval schedule is known beforehand.

- ♦ Round-Based Disk Scheduling

- Read one data block for each video stream in each round.
- Retrievals in a round are serviced using SCAN.

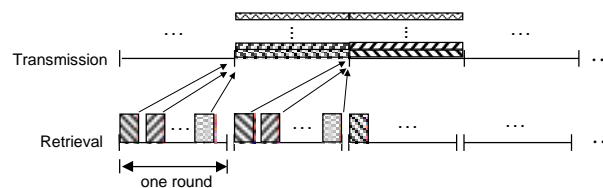

3.2 Video Retrieval

Jack Y.B. Lee

- Disk Scheduling Algorithms for VoD Servers

- ♦ Round-Based Disk Scheduling

- To ensure the continuity of data flow for transmission, we need **two buffers per video stream**.
- Limitations
 - All video streams must have the same data rate; or
 - The data rate must be an integer multiple of a base data rate.

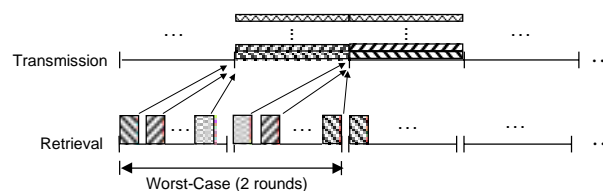

3.3 Admission Control

Jack Y.B. Lee

- Admission Control
 - ♦ Motivation
 - A VoD system only have finite capacity. Hence a mechanism must be used to admit and reject users to avoid system overload.
 - ♦ Types of Admission Control Algorithms
 - Deterministic
 - Worst-case scenarios are used to guarantee the service of existing users.
 - Statistical
 - Statistical behaviors of the system are used to provide *probabilistic* guarantee. E.g. meeting deadline 99% of the time.
 - Observational
 - Current system status like utilizations are used to evaluate the admission of new users.

3.3 Admission Control

Jack Y.B. Lee

- Dealing with Missed Deadlines
 - ♦ Why?
 - Deadlines could be missed if the admission control algorithm is statistical or some other unexpected events occur.
 - ♦ What to do?
 - Ignore It
 - Causes service degradations such as jerky video, decoding error, scrambled video, audio clicks, etc.
 - Depends on how much and what kind of data is missed.
 - Error Concealment
 - Repeating data (previous frame, audio packet, etc.)
 - Skipping video frame
 - Lower the resolution (temporary)

3.4 I/O Bandwidth

Jack Y.B. Lee

- Increasing Disk Throughput

- ◆ Background

- A single disk's through can serve a very limited number of concurrent users.
 - For example, a SCSI harddisk can serve around 10 MPEG1 video streams and 3~4 MPEG2 video streams.

- ◆ Replication

- Use multiple disks, each carry a separate copy of a movie.
 - Expensive since movie is large in size.

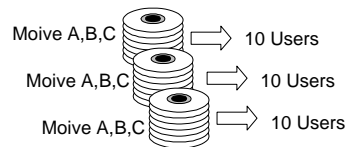

3.4 I/O Bandwidth

Jack Y.B. Lee

- Increasing Disk Throughput

- ◆ Partition

- Use multiple disks, each carry different movie titles.

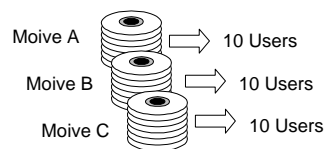

- Same total storage but poor load-balancing.

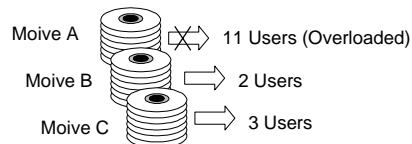

3.4 I/O Bandwidth

Jack Y.B. Lee

- Increasing Disk Throughput
 - ♦ Disk Striping (Disk Array)
 - Divides a video stream into units and distributes over all disks in the array.

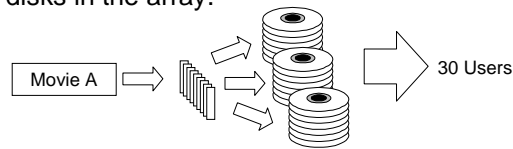

Data Organization:

	D ₀	D ₁	D ₂
B ₀	b ₀	b ₁	b ₂
B ₁	b ₃	b ₄	b ₅
B ₂	b ₆	b ₇	b ₈
B ₃	b ₉	b ₁₀	b ₁₁
B ₄	b ₁₂	b ₁₃	b ₁₄

3.4 I/O Bandwidth

Jack Y.B. Lee

- Increasing Disk Throughput
 - ♦ Disk Striping (Disk Array)
 - One logical *stripe* is retrieved per stream per round.

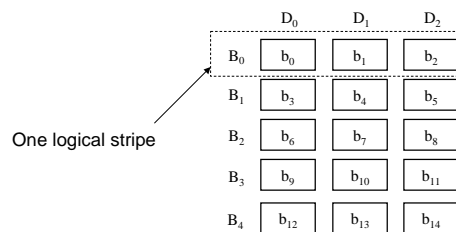

- Hence the throughput is N times those of a single disk if there are N disks in the array.
- The disks are *spindle synchronized*.

3.4 I/O Bandwidth

Jack Y.B. Lee

- Increasing Disk Throughput
 - ♦ Disk Interleaving
 - Same as disk striping except one logical unit is retrieved from one of the disk per stream per round.

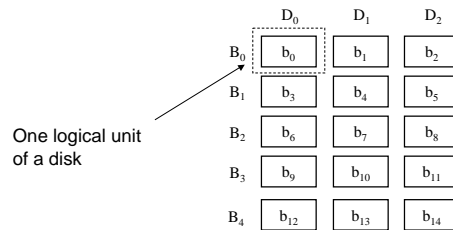

- Hence each disk can serve a different stream at the same time, or multiple streams are served concurrently.
- The disks are not spindle synchronized and operates independently.

3.5 Storage Capacity

Jack Y.B. Lee

- Tertiary Storage and Storage Hierarchies
 - ♦ Motivation
 - While magnetic disks are suitable for use in VoD systems due to the high throughput and low latency, *they are still expensive*.
 - For applications like video library where large number of videos must be archived, storing all video in disks will become prohibitively expensive (and unnecessary).
 - ♦ Tertiary Storage

Feature	Magnetic Disk	Optical Disk	Low-end Tape	High-end Tape
Capacity	9GB	200GB	500GB	10TB
Mount time	None	20 secs	60 secs	90 secs
Transfer Rate	2MBps	300KBps	100KBps	1MBps
Cost	\$5,000	\$50,000	\$50,000	\$0.5M to \$1M
Cost/GB	\$555	\$125	\$100	\$50

3.5 Storage Capacity

Jack Y.B. Lee

- Tertiary Storage and Storage Hierarchies
 - ♦ Tertiary Storage
 - Pros
 - Removable media like optical disks and tapes are less expensive in terms of cost per GB.
 - Cons
 - Lower data transfer rate;
 - Very long random access time.
 - ♦ Storage Hierarchy
 - Combines the cost-effectiveness of tertiary storage with the performance of magnetic disks.
 - Tertiary storage are used for permanent storage and the magnetic disks used as a cache for video delivery.

3.5 Storage Capacity

Jack Y.B. Lee

- Tertiary Storage and Storage Hierarchies
 - ♦ Storage Hierarchy

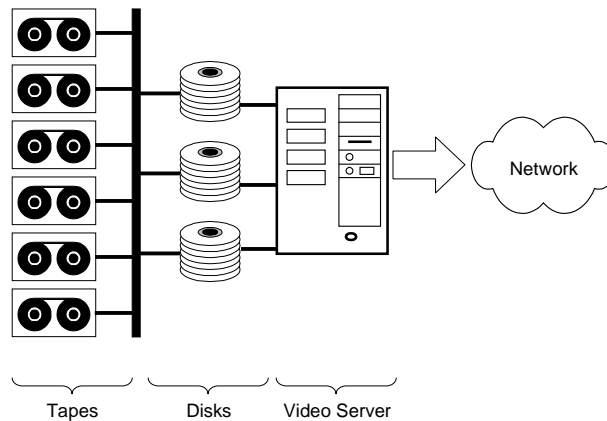

3.5 Storage Capacity

Jack Y.B. Lee

- Tertiary Storage and Storage Hierarchies
 - ◆ Storage Hierarchy
 - Scheme 1:
 - Store the beginning segments of videos in magnetic disk and the rest in tertiary storage;
 - Starts delivery from magnetic disk while downloading the rest of the video from the tertiary storage.
 - Scheme 2:
 - Downloads an entire video from tertiary storage to magnetic disks for delivery.
 - Manage the disk storage using most-recently-used policy.
 - Long startup time for uncached video but the caching should perform well since only a small number of video will be popular at any one time.

3.6 Video Delivery - LAN

Jack Y.B. Lee

- LAN-Based VoD Systems
 - ◆ Characteristics
 - Good Points:
 - Cost of network equipment is relatively low;
 - Most hardware and software are off-the-shelf products;
 - Mature and open platforms;
 - Network bandwidth can easily be added;
 - System expansion is easy;
 - Can coexist with existing computer applications.
 - Limitations:
 - Geographical span is limited to a few kilometers;
 - Limited user population;
 - More computer oriented (more demanding on the user).

3.6 Video Delivery - LAN

Jack Y.B. Lee

- LAN-Based VoD Systems
 - ♦ Shared Broadcast Networks (Ethernet)
 - Very low cost;
 - Very limited network capacity;
 - Collisions further reduces network throughput;
 - Network is the bottleneck.

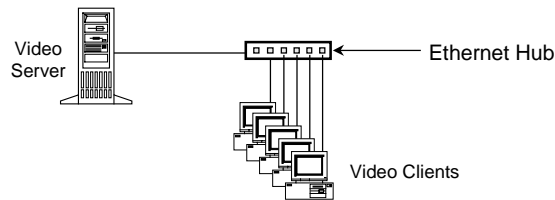

A 10Mbps shared Ethernet segment can support 5~7 MPEG-1 video streams.

3.6 Video Delivery - LAN

Jack Y.B. Lee

- LAN-Based VoD Systems
 - ♦ Switched Broadcast Networks (Switched Ethernet)
 - Each switched-port is independent and has *dedicated* bandwidth (10Mbps for Ethernet, 100Mbps for FastEthernet);
 - More expensive hardware (switch);
 - More scalable (i.e. expandable to more users);
 - Off-the-shelf switches have 2~10Gbps capacity;
 - Video server is likely to be the bottleneck.

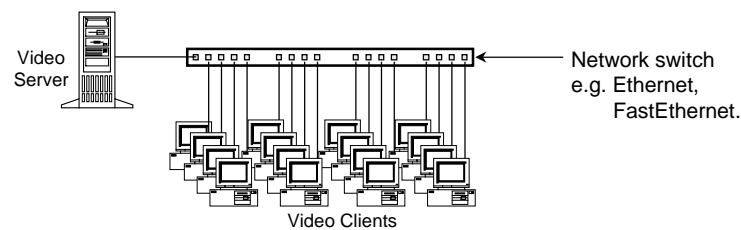

3.6 Video Delivery - LAN

Jack Y.B. Lee

- LAN-Based VoD Systems
 - ♦ Mixed Switched and Shared Broadcast Networks
 - More cost-effective than pure switch-based solution.

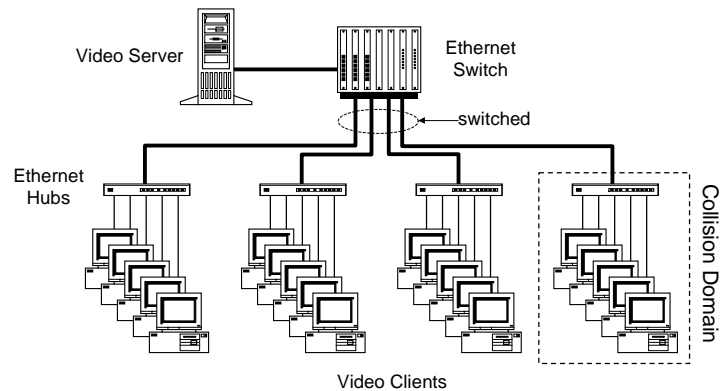

3.6 Video Delivery - WAN

Jack Y.B. Lee

- WAN-Based VoD Systems
 - ♦ Challenges
 - Large geographical area;
 - Large user population;
 - Must coexist with the POTS (Plain Old Telephone System);
 - Cost of network equipment is relatively high;
 - Network bandwidth is expensive to add;
 - Network delay is much higher than LAN;
 - Upstream bandwidth is limited;
 - A substantial part of the infrastructure is analog.

3.6 Video Delivery - WAN

Jack Y.B. Lee

- WAN-Based VoD Systems
 - ◆ Analog Near Video-on-Demand Approach

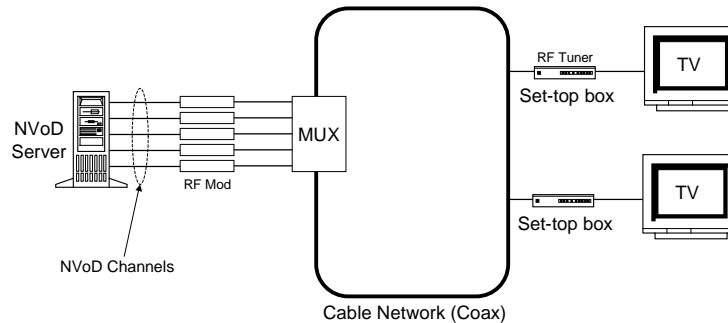

3.6 Video Delivery - WAN

Jack Y.B. Lee

- WAN-Based VoD Systems
 - ◆ Analog Near Video-on-Demand Approach
 - Low-cost
 - Utilizing existing cable network infrastructure;
 - Simple set-top box (just a RF-tuner);
 - Coexist with broadcast and cable TV channels;
 - Independent of number of users.
 - Limited Interactive Control
 - No reverse path for control signalling (use the phone);
 - Limited number of channels on a cable (a 450Mhz plant using 6Mhz analog channels supports ~70 channels);
 - Not true VoD (e.g. waiting time ~15 minutes);
 - Little or no VCR control;
 - Limited number of movie selections.

3.6 Video Delivery - WAN

Jack Y.B. Lee

- WAN-Based VoD Systems
 - ◆ Hybrid Fiber Coax (HFC) Approach

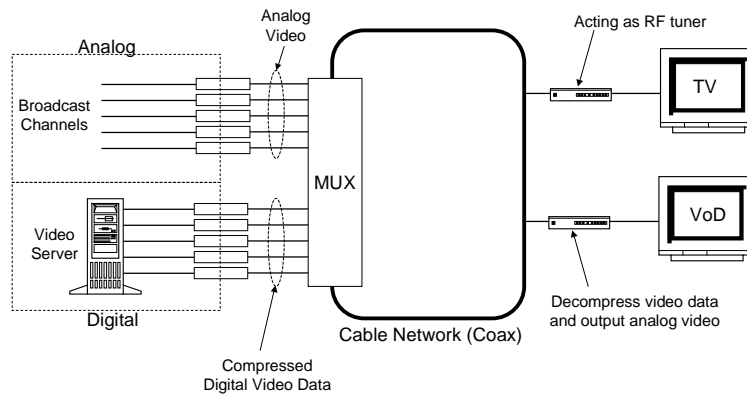

3.6 Video Delivery - WAN

Jack Y.B. Lee

- WAN-Based VoD Systems
 - ◆ Hybrid Fiber Coax (HFC) Approach
 - Bandwidth
 - Assume a 750 Mhz cable network;
 - Each 6 Mhz channel can carry 1 analog video channel or 40 Mbps digital data;
 - One 6 Mhz channel can carry ~10 MPEG-2 streams;
 - Example:
 - Delivers 70 analog video broadcast channels using 450 Mhz;
 - Delivers 500 VoD streams in the remaining 300 Mhz bandwidth.

3.6 Video Delivery - WAN

Jack Y.B. Lee

- WAN-Based VoD Systems
 - ♦ Approaches Using Twisted-Pair Telephone Cables
 - Asymmetric Digital Subscriber Line (ADSL)
 - ~6 Mbps downstream bandwidth shared by VoD, POTS and ISDN services.
 - High-speed Digital Subscriber Line (HDSL)
 - 1.544 Mbps full duplex bandwidth.
 - Asynchronous Transfer Mode (ATM)
 - >10 Mbps bandwidth.

3.6 Video Delivery - WAN

Jack Y.B. Lee

- WAN-Based VoD Systems
 - ♦ Approaches Using Twisted-Pair Telephone Cables

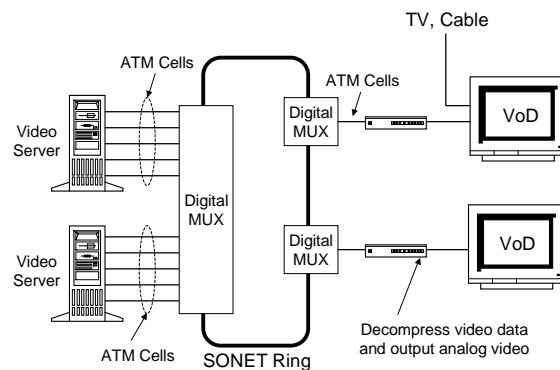

Part 4 - Applications

Jack Y.B. Lee

- Contents
 - ◆ 4.1 Entertainment
 - ◆ 4.2 Education and Training
 - ◆ 4.3 Video Library
 - ◆ 4.4 Networked Video Kioks
 - ◆ 4.5 Online Commerce

4.1 Entertainment

Jack Y.B. Lee

- Applications
 - ◆ Movie-on-demand
 - ◆ Karaoke-on-demand
 - ◆ MTV-on-demand
- System Requirements
 - ◆ Broadcast-quality video
 - ◆ High-quality audio (AC-3, DTS)
 - ◆ Interactive VCR controls
 - ◆ Large user population
- Suitable Technologies
 - ◆ MPEG-2 compressed video (>3Mbps)
 - ◆ Set-top box type video client
 - ◆ True VoD or good NVoD architecture

4.2 Education and Training

Jack Y.B. Lee

- Applications
 - ◆ Video courseware and training
 - ◆ Distance learning and tele-lecturing
- System Requirements
 - ◆ Medium to good quality video
 - ◆ Voice-grade audio
 - ◆ Interactive VCR controls
 - ◆ Multimedia content composition, delivery, and synchronized playback
 - ◆ Small user population

4.2 Education and Training

Jack Y.B. Lee

- Suitable Technologies
 - ◆ MPEG-1 compressed video
 - ◆ Computer type video client
 - ◆ True VoD architecture with multimedia support
 - ◆ LAN-based VoD system

4.3 Video Library

Jack Y.B. Lee

- Applications
 - ◆ Films and videos archival
- System Requirements
 - ◆ Broadcast-quality to HDTV-grade video
 - ◆ High-quality audio
 - ◆ Interactive VCR controls
 - ◆ Huge amount of storage (TeraBytes)
 - ◆ Small user population
- Suitable Technologies
 - ◆ MPEG-2 compressed video (>10Mbps for HDTV)
 - ◆ True VoD architecture
 - ◆ Storage hierarchy (tapes plus disks)
 - ◆ LAN-based VoD system

4.4 Networked Video Kiosks

Jack Y.B. Lee

- Applications
 - ◆ Tourists information kiosks at airport
 - ◆ Visitors information kiosks at shopping centre, museum, etc.
- System Requirements
 - ◆ Medium to good quality video
 - ◆ Voice-grade audio
 - ◆ Interactive VCR controls via touch screen
 - ◆ Multimedia content composition, delivery, and synchronized playback
 - ◆ Small user population

4.4 Networked Video Kiosks

Jack Y.B. Lee

- Suitable Technologies
 - ♦ MPEG-1 compressed video
 - ♦ Computer type video client (embedded)
 - ♦ True VoD architecture with multimedia support
 - ♦ LAN-based VoD system

4.5 Online Commerce

Jack Y.B. Lee

- Applications
 - ♦ Online shopping, banking, marketing, etc.
- System Requirements
 - ♦ Good to broadcast quality video
 - ♦ High-quality audio
 - ♦ Interactive VCR controls
 - ♦ Multimedia content composition, delivery, and synchronized playback
 - ♦ Videoconferencing
- Suitable Technologies
 - ♦ MPEG-1 to MPEG-2 compressed video
 - ♦ Set-top box type video client with camera
 - ♦ True VoD with multimedia support

Summary

Jack Y.B. Lee

- Technologies
 - ♦ Server, network, and client technologies are ready;
 - ♦ The cost is still high today for broadcast-quality VoD applications;
- Systems
 - ♦ Deployable VoD system solutions are available;
 - ♦ Still lacks a uniform standard across equipment from different vendors, interoperability is limited;
- Applications
 - ♦ Many existing applications can already be improved by VoD (e.g. Movie-on-Demand v.s. Movie-Rental);
 - ♦ More and more applications will be benefited when the cost comes down along improvements in hardware and software.

References

Jack Y.B. Lee

- Part of the materials in this workshop is based on:

- [1] R.D.Williams, "Multimedia Networks: Issues and Challenges," *IEEE Computer*, vol.28(4), April 1995, pp.68-69.
- [2] B.Furht, et al., "Design Issues for Interactive Television Systems," *IEEE Computer*, vol.28(5), May 1995, pp.25-39.
- [3] A.L.Narasimha Reddy, et al., "I/O Issues in a Multimedia System," *IEEE Computer*, vol.27(3), March 1994, pp.69-74.
- [4] D.J.Gemmell, "Multimedia Storage Servers: A Tutorial," *IEEE Computer*, vol.28(5), May 1995, pp.40-49.
- [5] A.S.Tanenbaum, *Computer Networks*, 3rd Edition, Prentice-Hall, 1996.
- [6] S.V.Raghavan & S.K.Tripathi, *Networked Multimedia Systems*, Prentice-Hall, 1998.
- [7] MPEG Overview by C-Cube Systems, <http://www.c-cube.com/technology/mpeg.html>.
- [8] MPEG Audio Introduction by David Renelt, <http://www.raum.com/mpeg/introduction.html>.